

Website



Online Store



Joyusing Technology Co.,Ltd



V500S  
DOCUMENT CAMERA  
**USER MANUAL**

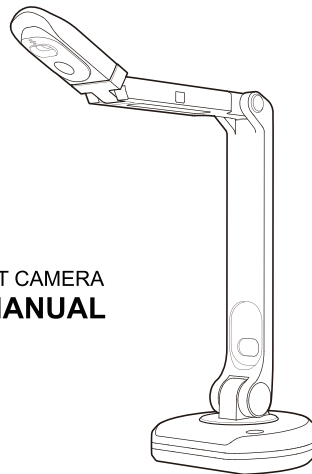

**Website:** [www.joyusing.com](http://www.joyusing.com)  
**Email:** [Support@joyusing.com](mailto:Support@joyusing.com)  
**Online Store:** [store.joyusing.com](http://store.joyusing.com)

# CATALOGUE

## Hardware Description

1. Safety Measures .....	01
2. List of Accessories .....	02
3. Operating Instructions .....	03
4. Installation and Connection .....	04

## Software Description

### Windows

1. Software Introduction .....	05
2. System Requirements .....	05
3. Installing Software .....	05
4. Connecting Hardware .....	07
5. Using the Software .....	07
5.1. Function Description .....	07
5.1.1. Snap .....	08
5.1.2. Video-Recording .....	09
5.1.3. OCR .....	11
5.2. Function Description for the Bottom Icons .....	12
5.3. Function Description for the Right Icons .....	13
5.4. Images Preview .....	14
5.5.The Settings .....	14
5.5.1.About Settings .....	15
5.5.2.Save Settings .....	15
5.5.3.Format Settings .....	16

### Mac

1. Software Introduction .....	17
2. System Requirements .....	17
3. Installing Software .....	17
4. Connecting Hardware .....	19
5. Using the Software .....	19

5.1. Function Description .....	19
5.1.1. Snap .....	20
5.1.2. Video-Recording .....	22
5.2. Function Description for the Bottom Icons .....	23
5.3. Function Description for the Right Icons .....	24
5.4. Images Preview .....	25
5.5.The Settings .....	25
5.5.1.About Settings .....	26
5.5.2.Save Settings .....	26
5.5.3.Format Settings .....	27

### Chrome

1. Notes .....	28
2. Installation Software .....	28
3. Connecting Equipment .....	30
4. Start to work .....	30
5. Software Function Description .....	31
5.1 Main Window .....	31
5.1.1 Icon Descriptio .....	31
5.1.2 System Settings .....	31
5.2 Function Description for the Bottom Icons .....	32
5.2.1 Take Photo .....	32
5.2.2 Video Recording .....	32
5.2.3 Screen Capture .....	33
5.2.4 Time-lapse Photography .....	34
5.2.5 Stop-motion Animation .....	34
5.2.6 QR Code Scan .....	35
5.3 Function Description for the Left Icons .....	35
5.4 Function Description for the Bottom Icons .....	40

## FAQ

FAQ .....	42
-----------	----

# Hardware Description

## 1. Safety Measures

Please be sure to follow the safety instructions when you are in setting and using document camera.

1. Do not tilt the document camera in using.
2. Do not place the document camera near the unstable carts, countertops, or desks.
3. Do not use document cameras at the edge of the water or heat source.
4. Using only accessory devices recommended by the original manufacturer.
5. Please use the power type indicated in the document camera. If you are not sure about it, please check with your distributor or local power company.
6. Please place the document camera in a place where the plug can be easily removed.
7. When using the plug, please be sure to follow the following safety measures in case of sparks or fires.
  - Please remove the dust from the plug before inserting it into the socket.
  - Please plug in it firmly.
8. Do not share wall sockets, extension wires, or porous sockets with multiple plugs in case of fire or electric shock.
9. Do not place the the wires of document cameras where they will be easily trampled, so as not to wear or damage the wires or plugs.
10. Please unplug the document camera before cleaning it. Please clean it with a wet cloth, do not use liquid or spray cleaner.
11. Do not block the external grooves or holes of digital document camera, because it will obstruct its ventilation and heat dissipation. Do not put the document camera on the sofa, carpet or other soft surface; Do not install the document camera in an embed manner unless proper ventilation is provided.
12. Do not plug foreign matter into the groove of the document camera. Please do not wet the document camera with liquid.
13. Do not operate the document camera on your own thoughts. Please operate it with specially instructed in the user manual. Opening or removing the outer cover may cause dangerous voltage or other hazards.

14. Please unplug the power during thunderstorms or long time without using. Do not place the document camera or remote controller on vibrating things or hot objects, such as cars, oven, etc.
15. If you have the following problems, please unplug the digital document camera and ask for our after-sales & maintenance service
  - When the power cable or plug is worn out or damaged.
  - When the document camera is wet with liquid, rain, or water.

<Note>

- The remote controller with the wrong model battery may be unable to work. Please discard the old batteries as instructed
- Do not expose the device to rain or moisture in case it will cause fire or electric shock.

## 2. List of Accessories

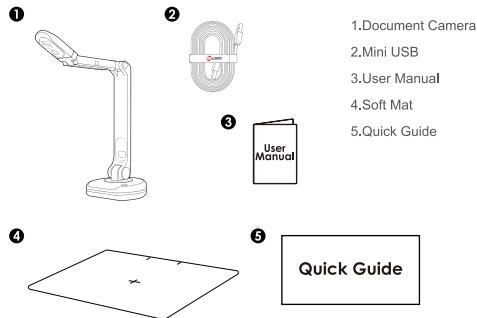

### 3. Operating Instructions

#### ▶ Product Preview

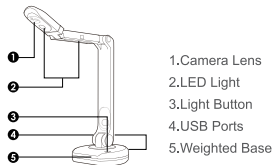

#### Ports type

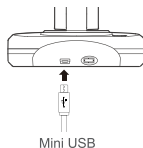

#### ▶ Product Preparation

##### Setting up

- 1.Lift up camera arm vertically.

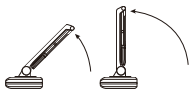

- 2.Rotate the arm 180° to the reverse side.

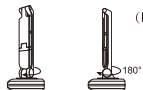

- 3.Lift up the camera head to be horizontal with the panel.

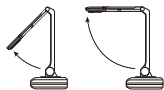

##### Camera moving parts illustration

- 1.Camera arm 180° rotates.

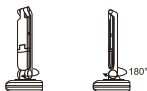

- 2.Camera arm 135° flips.

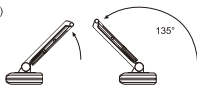

- 3.Camera head (Left:90°,Right:90°) rotates + 135° flips.

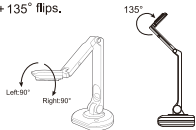

### 4. Installation and Connection

#### USB to Computer

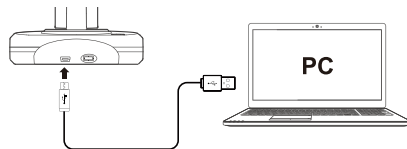

1. Connect the USB cable to the PC and Document Camera.
2. Install the software.

#### Connect to Display Ports

HDMI cable can be connected to monitor, projector, HDTV, and touch screen, etc.

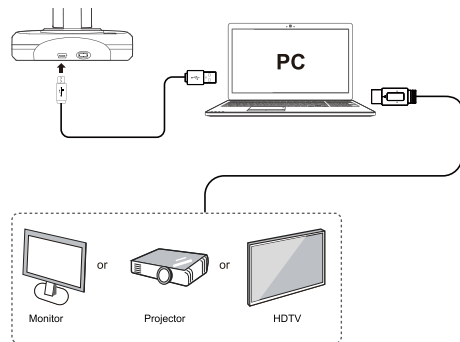

## Windows

### 1. Software Introduction

After installing Visualizer software, the following functions are available for you. To control the function of image shooting and video recording. The picture comes with annotation that can be saved. It can support image freezing, rotation, zoom-in, zoom-out, etc. It supports full-screen recording. It supports for OCR recognition. It supports picture-in-picture, split-screen, and camera selection.

### 2. System Requirements

Windows 7 / 8 / 10 & XP and above  
Minimum CPU: i3 or above  
Minimum memory: 4G RAM  
Minimum hard disk space: 128GB  
Support Direct X 9 (WDDM 1.0 or later version)

### 3. Installing Software

Installing must be based on Windows Vista / 7 / 8 / 10 & XP

- Please link to the website: [www.joyusing.com/download.html](http://www.joyusing.com/download.html) and download the software of Visualizer (windows).
- After downloading the file, please click on the icon  to install.
- The Installation assistant will guide you to install, please follow the on-screen instruction and press [Next] to proceed to the next step. The steps are as follows:

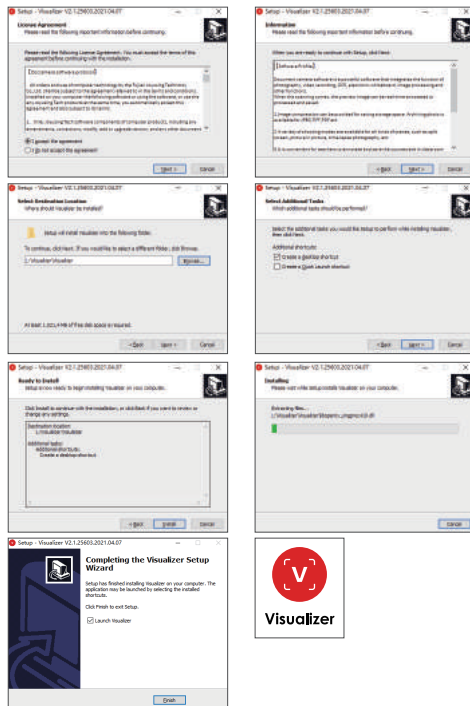

## 4. Connecting Hardware

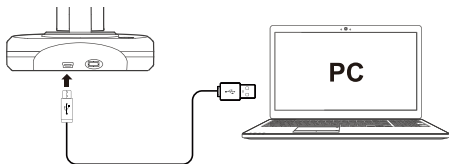

1. Connect the USB cable to the PC and Document Camera.
2. Install the software.

## 5. Using the Software

Double-click on the icon to the main interface of software. Shown as:



### 5.1. Function Description



#### 5.1.1. Snap

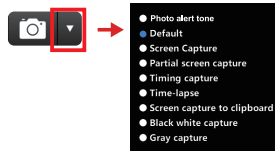



- **Photo alert tone:** Be closed by default, and be opened by click.
- **Default:** Video previewed by the camera, shown as:



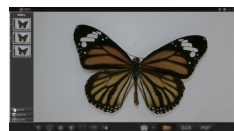

- **Screen capture:** The entire software interface, Shown as:

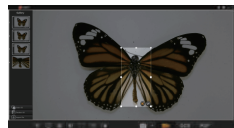

- **Partial screen capture:** You can zoom in and zoom out the selected area that you want, and then click on the icon  to capture. Click on the icon  to exit. The range of partial screen capture is adjustable, Shown as:



- **Timing capture:** When you click on the icon , the screen will pop up the interval time and capture pages. Please set them and then click on the icon  to finish. Shown as:



- **Time-lapse:** Please click on the icon  to start time-lapse photography. It will be a video automatically based on your captured images.



- **Screen capture to clipboard:** You can copy all on the screen and then paste them directly to your document instead of presenting them on the left gallery.
- **Black white capture:** Captured color images by camera can be converted to black and white images.
- **Gray capture:** Captured color images by camera can be converted to gray images.

## ▶ 5.1.2. Video-Recording



- **Operation:** When you click on the icon, the screen will pop up the following picture. You can choose the resolution you want. The range of video-recording is adjustable, including full screen, 1024x768, 1080x720, 800x600, 640x480.

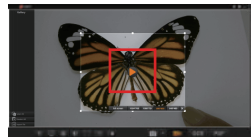

- ▶ **Clicking on the icon to start video-recording.**

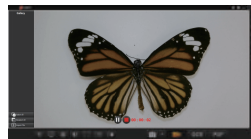

- ▶ **Clicking on the icon to pause the video-recording.**

- ▶ **Clicking on the icon to stop the video-recording and saving it in the default path.**



### ► 5.1.3. OCR

#### OCR

**Operation:** Please select one picture or many pictures on the left gallery, and then click on the icon, the screen will pop up the following picture:

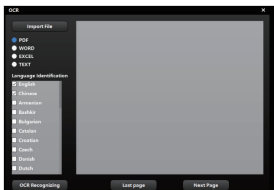

#### OCR Recognizing

Please select the detail language identification and import file, and then click on the icon and save it.

**Note:** To select the language identification is to improve the OCR recognition and the accuracy of documents.

#### Import File

You can select the document that needs to be identified by OCR from the computer folder.

### ► 5.1.4. PDF











#### PDF

**Operation:** Click on the icon of Gallery to preview the image and then output it as a PDF.

## 5.2. Function Description for the Bottom Icons



### Function Description

Icon	Function Descriptions
 <b>Focus and exposure</b>	Clicking on the icon to adjust focus and exposure. Shown as: 
 <b>Resolution</b>	Selecting the proper resolution. Shown as: 
 <b>Freeze</b>	Freezing the selected area that you want.
 <b>Color-adjusting</b>	Adjusting the contrast, brightness and saturation. Shown as: 
 <b>Automatic-edging</b>	Professional trimming is ready for the detail area of video.
 <b>Picture-in-picture</b>	Allow you to stream two document cameras at the same time by creating a mini window inside Visualizer.
 <b>Split-screen</b>	Select an image for comparison.



### 5.3. Function Description for the Right Icons

**Board:** Display all function keys of the board, shown as follows:

Icon	Function Descriptions
	The details of video preview can be moved.
	You can annotate the previewed picture in the video.
	Selecting the corresponding one to adjust the size of the pencil.
	Selecting the corresponding one to adjust the color of the pencil.
	The scroll bar can adjust the pencil and transparency.
	Be able to write down the text description for the preview images.
	Freezing the selected area that you want.
	The annotations on the image can be erased, and the scroll bar can resize the eraser.
	You can clear out all annotations on the image.
	Back to the previous menu.

Icon	Function Descriptions
	To magnify the selected area.
	Zoom-in the selected area that you want.
	Zoom-out the selected area that you want.
	Rotating to the right 90° per time, including 90°/180°/270°.
	To display the real size of the video preview area.

### 5.4. Images Preview

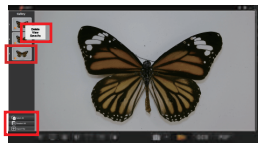

**Function:** When you right-click on the selected picture, the screen will pop up three options.

Icon	Function Descriptions
	To eliminate the image.
	To see the details of the image.
	The selected image can be converted to the format you want.



Icon	Function Descriptions
	Selecting all preview images.
	To deselect the selected images.
	To load images.

### 5.5. The Settings



### ▶ 5.5.1. About Settings

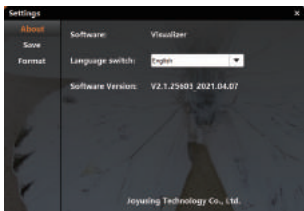

About: Software, Language switch, Software version

### ▶ 5.5.2. Save Settings

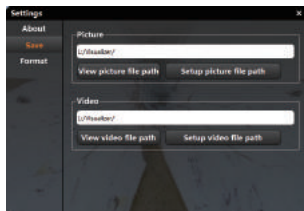

**View picture file path** Opening the path where the picture is located.

**Setup picture file path** You can change the setting of the default picture path.

**View video file path** Opening the path where the video is located.

**Setup video file path** You can change the setting of the default video path.

### ▶ 5.5.3. Format Settings

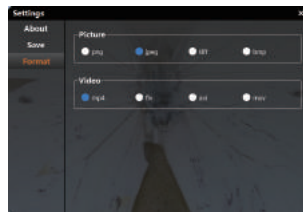

The icon means selected area that you can set the format of picture and video in advance.



Picture



Video

### 5.6. Cameras

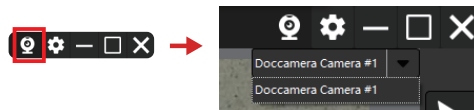

When multiple cameras are connected to the computer, please select a camera you want for display.

## 1. Software Introduction

After installing Visualizer software, the following functions are available for you.

To control the function of image shooting and video recording.

The picture comes with annotation that can be saved.

It can support image freezing, rotation, zoom-in, zoom-out, etc.

It supports full-screen recording.

It supports for OCR recognition.

It supports picture-in-picture, split-screen, and camera selection.

## 2. System Requirements

Mac OS 10.10 -10.15

Minimum CPU: I3 or above

Minimum memory: 4G RAM

Minimum hard disk space: 128GB QuickTime 7,4.5 above

## 3. Installing Software

### Installing must be based on MAC OS 10.10 -10.15

- Please link to the website: [www.joyusing.com/download.html](http://www.joyusing.com/download.html) and download the software of Visualizer (MAC).
- After downloading the file, please click on the icon  to install.
- The Installation assistant will guide you to install, please follow the on-screen instruction and press [Next] to proceed to the next step. The steps are as follows:

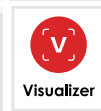
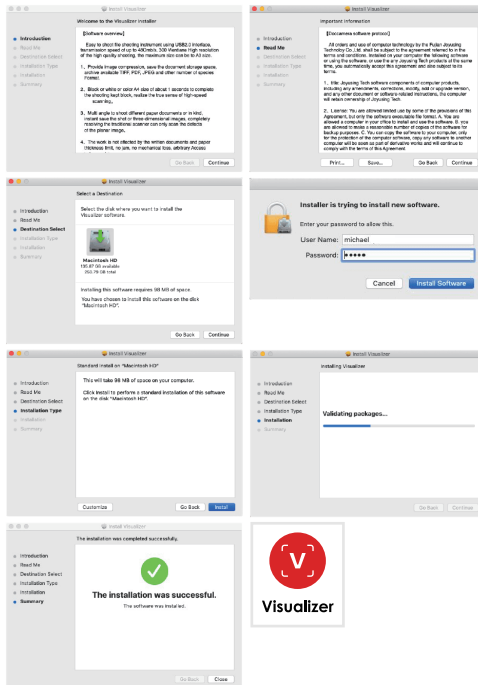

## 4. Connecting Hardware

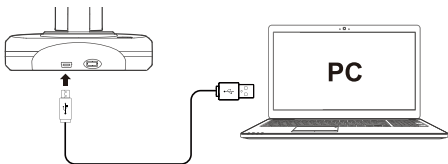

1. Connect the USB cable to the PC and Document Camera.
2. Install the software.

## 5. Using the Software

Click on the icon to the main interface of software.  
Shown as:

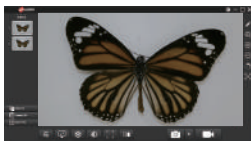

### 5.1. Function Description



#### 5.1.1. Snap

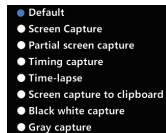

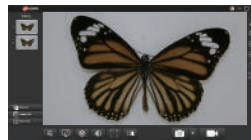

■ **Default:** Video previewed by the camera, shown as:



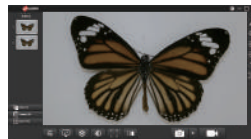

■ **Screen capture:** The entire software interface, Shown as:



■ **Partial screen capture:** You can zoom in and zoom out the selected area that you want, and then click on the icon  to capture. Click on the icon  to exit. The range of partial screen capture is adjustable, Shown as:



- **Timing capture:** When you click on the icon , the screen will pop up the interval time and capture pages. Please set them and then click on the icon  to finish. Shown as:

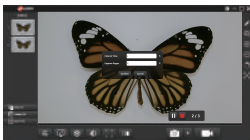

- **Time-lapse:** Please click on the icon  to start time-lapse photography. It will be a video automatically based on your captured images.

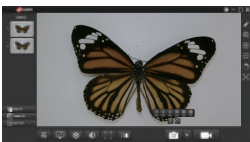

- **Screen capture to clipboard:** You can copy all on the screen and then paste them directly to your document instead of presenting them on the left gallery.
- **Black white capture:** Captured color images by camera can be converted to black and white images.
- **Gray capture:** Captured color images by camera can be converted to gray images.

## ▶ 5.1.2. Video-Recording



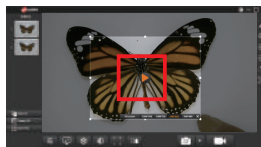

- **Operation:** When you click on the icon, the screen will pop up the following picture. You can choose the resolution you want. The range of video-recording is adjustable, including full screen, 1024x768, 1080x720, 800x600, 640x480.

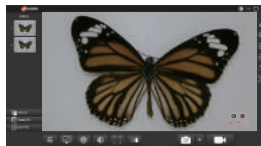

-  **Clicking on the icon to start video-recording.**



-  **Clicking on the icon to pause the video-recording.**
-  **Clicking on the icon to stop the video-recording and saving it in the default path.**

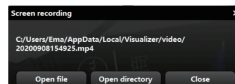

## 5.2. Function Description for the Bottom Icons



Icon	Function Descriptions
<b>Focus and exposure</b>	Clicking on the icon to adjust focus and exposure. Shown as:
<b>Resolution</b>	Selecting the proper resolution. Shown as:
<b>Freeze</b>	Freezing the selected area that you want.
<b>Color-adjusting</b>	Adjusting the contrast, brightness and saturation, Shown as:
<b>Automatic-edging</b>	Professional trimming is ready for the detail area of video.
<b>Split-screen</b>	Select an image for comparison.

## 5.3. Function Description for the Right Icons



**Board:** Display all function keys of the board, shown as follows:

Icon	Function Descriptions
<b>Move</b>	The details of video preview can be moved.
<b>Pencil</b>	You can annotate the previewed picture in the video.
<b>Thick-ness</b>	Selecting the corresponding one to adjust the size of the pencil.
<b>Color</b>	Selecting the corresponding one to adjust the color of the pencil.
<b>Transpa-ency</b>	The scroll bar can adjust the pencil and transparency.
<b>Text</b>	Be able to write down the text description for the preview images.
<b>Shape</b>	Freezing the selected area that you want.
<b>Eraser</b>	The annotations on the image can be erased, and the scroll bar can resize the eraser.
<b>Clear</b>	You can clear out all annotations on the image.
<b>Home</b>	Back to the previous menu.



Icon	Function Descriptions
<b>Magnifier</b>	To magnify the selected area.
<b>Zoom-in</b>	Zoom-in the selected area that you want.
<b>Zoom-out</b>	Zoom-out the selected area that you want.
<b>Rotate</b>	Rotating to the right 90° per time, including 90°/180°/270°.
<b>Self-adapting</b>	To display the real size of the video preview area.

## 5.4. Images Preview

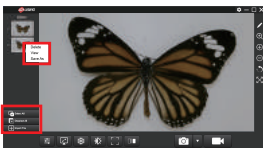

**Function:** When you right-click on the selected picture, the screen will pop up three options.

Delete View Save As	Icon	Function Descriptions
		To eliminate the image.
		To see the details of the image.
		The selected image can be converted to the format you want.



Selecting the existing images.



Icon	Function Descriptions
	Selecting all preview images.
	To deselect the selected images.
	To load images.

## 5.5. The Settings



### ▶ 5.5.1. About Settings

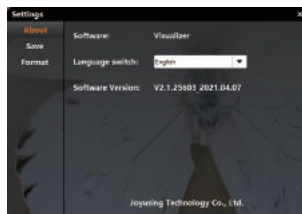

About: Software, Language switch, Software version

### ▶ 5.5.2. Save Settings

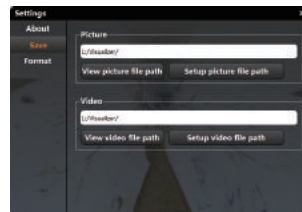

**View picture file path** Opening the path where the picture is located.

**Setup picture file path** You can change the setting of the default picture path.

**View video file path** Opening the path where the video is located.

**Setup video file path** You can change the setting of the default video path.

### ► 5.5.3. Format Settings

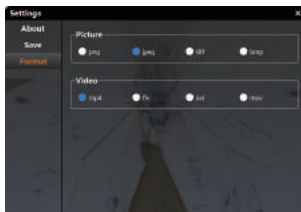

The icon means selected area that you can set the format of picture and video in advance.



Picture



Video

## Chrome

### 1. Notes

- 1.1 The resolution of video-recording, time-lapse photography, and stop-motion animation should be controlled under 1280×960
- 1.2 Video output with USB port requires chrome version 47 and above, screen recording requires chrome 72 and above (audio in recording requires version 74+ )
- 1.3 If there is no audio input device, the system will skip audio recording directly.
- 1.4 Chrome app does not support dynamic switching language, so you need to follow the system language. If there is no system language package, please use the default language set by the software (the default language can be set by yourself).

### 2. Installation Software

- 2.1 Please link to the website: [www.joyusing.com](http://www.joyusing.com)

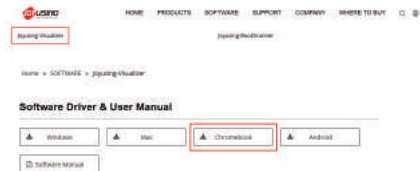

- 2.2 After successful download, double-click to extract the file , and you can see:

 Joyusing\_Visualizer\_Chrome OS\_V1.0.crx



2.3 Modify the file suffix to RAR format:

Joyusing\_Visualizer\_Chrome OS\_V1.0.rar

2.4 Double-click to extract the file again, and you can see the file:

Joyusing\_Visualizer\_Chrome OS\_V1.0

2.5 Google Browser – Extensions , open the Developer mode, and click the Load unpacked



2.6 Choose the file:

Joyusing\_Visualizer\_Chrome OS\_V1.0

2.7 Successful installation:

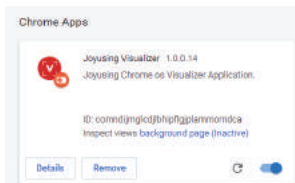

### 3. Connecting Equipment

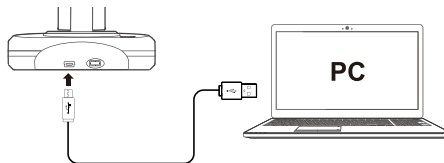

1. Connect the USB cable to the PC and Document Camera.
2. Install the software.

### 4. Start to Work

Double-click on it to run.

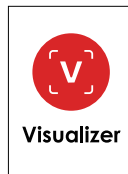

## 5. Software Function Description

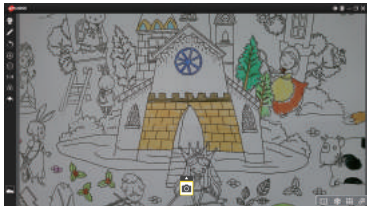

### 5.1 Main Window



#### ▶ 5.1.1 Icon Description

When you click on the icon , the screen will be linked to Joyusing website: <https://www.joyusing.com/>

#### ▶ 5.1.2 System Settings

 The icon means system settings, system, minimize, full screen, close. When you click on the icon , the screen will pop up several functions, including resolution, preview time, and photo timing.

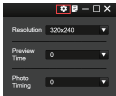

#### ■ Resolution:



You can select the corresponding resolution.

#### ■ Preview Time:



You can select the automatic preview time after the photo is taken, the unit is in second.

#### ■ Photo Timing:

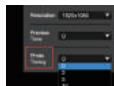

Once you select it, you will enter the countdown for taking photos.

### 5.2 Function Description for the Bottom Icons

When you clicking on the triangle of , the screen will pop up six instruction icons (Take photo, Video Recording, Screen Capture, Time-lapse photography, Stop-motion Animation)



#### ▶ 5.2.1 Take Photo







**Take Photo:** Clicking on the icon  to take photo and save them to photo album.  
Shown as: 

#### ▶ 5.2.2 Video Recording



When you click on the triangle, the screen will pop up like this

Please click on the icon  to start. When it comes to the picture like this , it means that you are in Video countdown time. (Note: Due to the limitations of Chrome's own system, 15 minutes of recording is the maximum & best recording effect.) Clicking on the icon  to pause the recording, while clicking on the icon  again to finish the current screen capture. Lastly, clicking on the icon  to view the recorded video.

Clicking on the icon  to start video recording

Clicking on the icon  to pause the recording





Clicking on the icon  to stop recording

Clicking on the icon  to view the recorded video

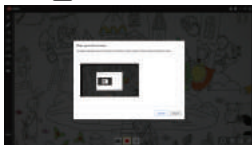
### ▶ 5.2.3 Screen Capture

When you click on the triangle, the screen will pop up like this  
Please click on the icon  to start, the screen will pop up the selection of the record area, shown as



Selecting the area you want to record and clicking on the button "share" When it comes to the picture like this , it means that you are in screen capture countdown time. (Note: Due to the limitations of Chrome's own system, 15 minutes of recording is the maximum & best recording effect.) Clicking on the icon  to pause the recording, while clicking on the icon  again to finish the current screen capture. Lastly, clicking on the icon  to view the recorded video.



Clicking on the icon  to start screen capture

Clicking on the icon  to pause the recording



Clicking on the icon  to stop recording

Clicking on the icon  to view the recorded video

### ▶ 5.2.4 Time-lapse Photography

When you click on the triangle, the screen will pop up like this  
Please clicking on the icon  to start time-lapse photography. When it comes to the picture like this , you can select the time, the unit is in second.





Clicking on the icon  again to start. When it comes to the picture like this , the icon  turns red, it means you are taking photos, taking a photo



for a frame, 30 frames to generate a second video. Clicking on the icon  to finish taking photos, while clicking on the icon  to pause. Clicking on the icon  again to finish the current photo. Lastly, clicking on the icon  to view the recorded video.

### ▶ 5.2.5 Stop-motion Animation



The fast production of dynamic video is available. When you click on the triangle, the screen will pop up like this 

Please click on the icon  to start. When it comes to the picture like this , please click on the icon , and you can select the detail time for every dynamic image shown as:



Clicking on the icon  one time for one one photo. When you finish it, dynamic images can not be saved. Lastly, clicking on the icon  to view the recorded video.

## ► 5.2.6 QR Code Scan

**Operation:** When you click on the triangle, the screen will pop up like this . Please click on the icon  to start. When it comes to the picture like the picture shown as follows. Then please scan the QR code.



## 5.3 Function Description for the Left Icons

**The icon** : Including switch camera, annotation, rotate, zoom in, zoom out, mirror, filter,



### Function Description:

Selecting the icon  to get video source that you want.

Operation shown as:  , please select what you want, and then you

can correct the image horizontally or vertically.

**Annotation:** When you click on the icon  , it comes to secondary interface, shown as:



• **Brush**  : You can annotate the previewed picture in the video.

• **Thickness**  : Selecting the corresponding one to adjust the size of the pencil.  
Shown as:



• **Color**  : Selecting the corresponding one to adjust the color of the pencil.  
Shown as:





• **Graphic**  : Adding the selected shape to the previewed picture in the video.  
Shown as:





- **Eraser**  : The annotations on the image can be erased, and the scroll bar can resize the eraser. Shown as:



- **Clear All**  : You can clear out all annotations on the image.
- **Return**  : Clicking on it to get back the document camera screen. Shown as:



**Rotate**  : Any angle is available.

- **Operation**  : The rotation angle can be selected for 90°, 180°, 270° or the sliding scroll bar for any rotation angle.



**Zoom in**  : Zoom in the video preview area

**Zoom out**  : Zoom out the video preview area

**Mirror**  : Horizontal mirror, vertical mirror, horizontal and vertical mirror.  
Shown as:

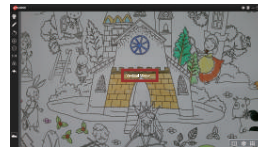
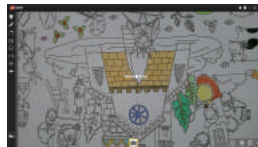

**Filter**  : Selecting the corresponding filter to preview the real-time screen.

- **Operation**  : The effect of the filter, shown as:

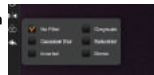

**No Filter**

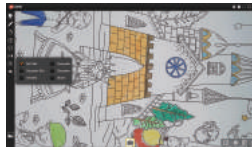

**Gray scale**



**Gaussian Blur**



**Saturation**



**Inverted**



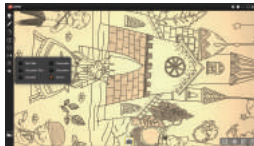

**Brown**



**Restore**  : All in one button to restore all video parameters, including rotation, mirror, zooming in, zooming out and filter.

**Photo Preview** 

For videos and photos taken during operation, please click on the icon  to view them.

**Operation** : When you click on the icon , the screen will pop up the picture like this ,

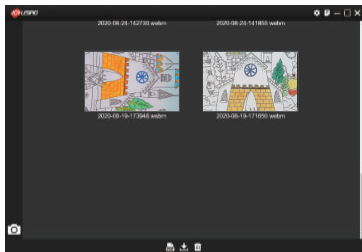

please double-click on the picture or video to get into picture preview shown as

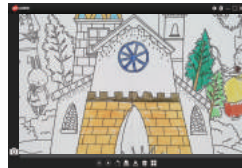

The details shown as , including the previous one, the next one, rotation, PDF, download, delete.

**Multiple Selection of Photos** : Please hold the shift button, you can select multiple photos with mouse, and batch operation is available.

## 5.4 Function Description for the Bottom Icons



**Reading mode:** 

Equipped with highlighter and magnifying glass modes, reading becomes more effective and much easier, such as data, magazines, documents, etc.

• **Operation:** Clicking on the icon  for better effective, shown as

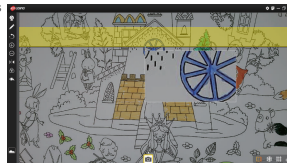

Clicking on the icon  again, with the effect of mask shown as



The mask range can be adjusted by right-clicking on the mouse.

**Freeze**  : Freeze the contents of the video preview area.

**Grid**  : It is convenient for you to align the footage for shooting under the grid lines.

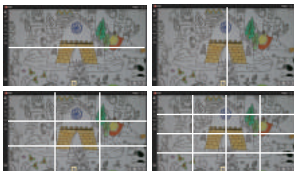

**Spotlight**  : The selected area will be highlighted, which is brighter than unselected ones.

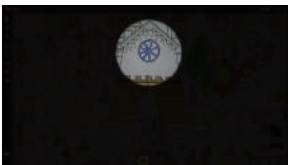

### Q: How to download visualizer software?

- A:** The software download options are as follow:
1. Go to our website [www.joyusing.com](http://www.joyusing.com) and then to "Support - Download". Please download the respective softwares according to the device models and computer systems.
  2. Search "Doccamera" in APP Store from your Mac.

### Q: How to solve the mirror effect issue when using the online meeting softwares, such as Zoom, Skype and Facebook.

- A:** The mirror effect is the function from the meeting softwares, please check and see if the mirror image is adjustable in the app.

### Q: How to turn off the auto-focusing or auto-exposure?

- A:** Please click the Focus and Exposure at the right corner, and cancel the automatic focus and exposure.

### Q: How to use the Document Camera software Visualizer?

- A:** Go to [www.joyusing.com](http://www.joyusing.com) and click "Support - Download" to select the Software User Manual for your document camera.

### Q: What should I do if the camera was not recognized by the software?

- A:**
1. Check and see if the device is connected to the computer.
  2. Use a different data cable to see if the cable is damaged.
  3. Try a different computer to check if the ports are good.

For more information, please visit our website [www.joyusing.com](http://www.joyusing.com) or contact to us: [Support@joyusing.com](mailto:Support@joyusing.com)