

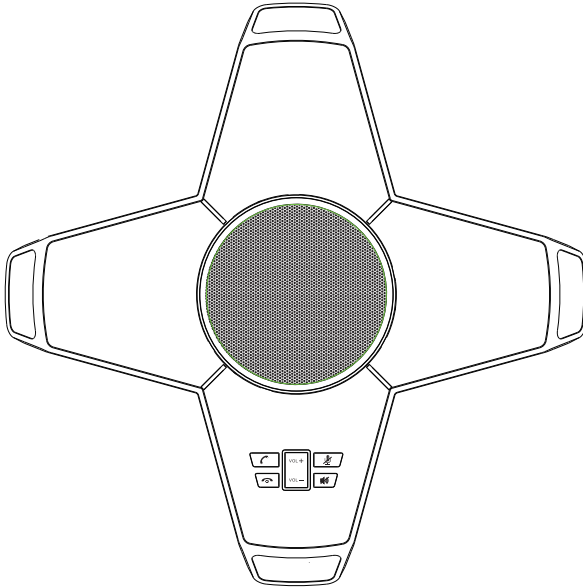

CONFERENCE SPEAKERPHONE CS31 SERIES



USER MANUAL

V1.0 (20200909)

CATALOGUE

PARTS LIST.....	2
S310 Series Conference Phone.....	2
Parts List.....	2
Optional Accessories.....	2
INSTALLATION AND PRECAUTIONS.....	3
Caution	3
Installing	3
Connection Diagram.....	4
Interface Introductions.....	5
Self-Detecting	5
GETTING TO KNOW YOUR PHONE.....	5
Parts of the Phone.....	5
S310 Keypad.....	6
LED Status.....	7
HOW TO USE S310.....	8
Placing a VoIP Call in USB Mode.....	8
Connection Steps for USB.....	8
Useful Settings for PC and Video Teleconferencing System.....	8
Placing a Call via LINE IN/OUT.....	8
Placing a Call via Mobile Phone.....	9
Connection Steps for Mobile Phone	9
Connection Steps for External Amplifier.....	9
MULTI-PARTY CONFERENCE CALL.....	10
INSTALLING EXTENSION MICROPHONE.....	10
IMPORTANT SAFETY INSTRUCTIONS.....	11

1. PARTS LIST

CS31 Series Conference Phone

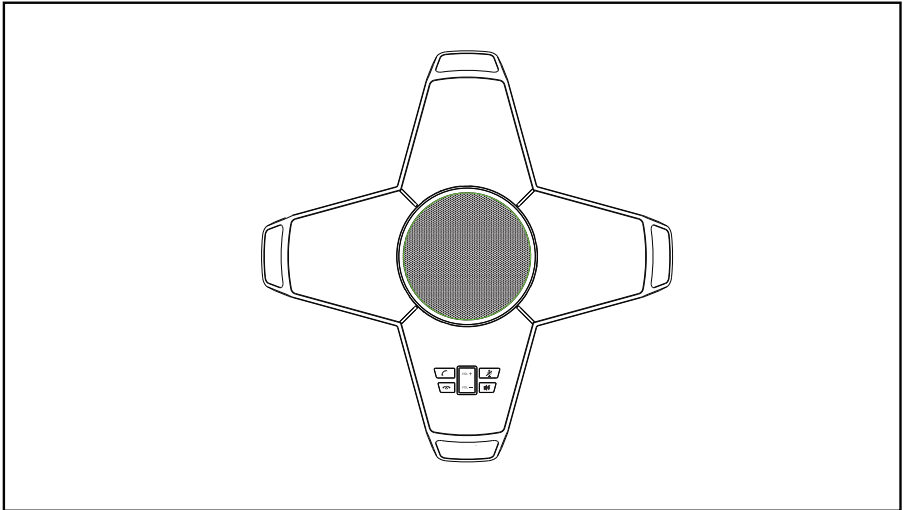

Parts List

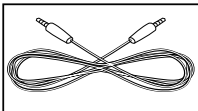

4 Strand 3.5MM Cable

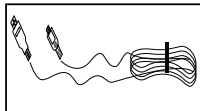

USB Cable



User Manual

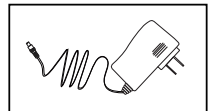

Adaptor



6.5m Length Power Extension Cable

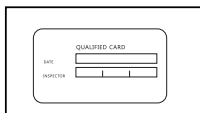

Certificate

Optional Accessories

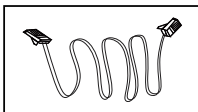

4P4C Cable x 3pcs



Extension Microphone
(up to 2pcs)

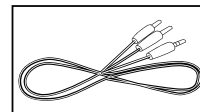

3.5mm cable

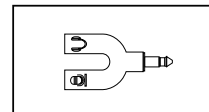

Audio Transfer plug

If any items are missing or damaged, contact your place of purchase immediately.
Do not use damaged products!

2. Installation and Precautions

For best performance of the device, please do not use it in the following kinds of locations:

- Areas with high background noise. The microphone(s) might pick up these sounds and prevent the speakerphone from going into receiving mode when finish talking.
- Place where the phone would be subject to vibrational forces.
- Uneven surface. Do not install or place it in a corner, under a cupboard, or next to a cabinet. These locations may cause an echo effect.
- Do not place any objects within 60cm from this device.

Caution:

To reduce the risk of personal injury, fire, or damaged, use the recommended power adaptor only.

Installing

1. If you need USB call, connect one end of USB cable into CS31 USB port, the other end into a PC or Video system.
2. If you need call by mobile phone, connect the earphone of mobile to "IN/OUT" port of CS31 by 4 Strand 3.5mm Cable.
3. When selecting two extension microphones, plug the optional extension microphones into EXT1 and EXT2 jacks of the CS31. This function is available for the CS31E model. When installing 2 extension microphones, use 4P4C cable to connect the phone and the 4P4C plug of the extension microphones.
4. If you need to get external amplifier connected, please plug one end of the 4 strand 3.5mm cable into "AUX" port of CS31, and the other end into the input port of amplifier (Only for USB Connection).
5. CS31 can support USB power supply, after USB connection with a PC or Video system, the CS31 will be into working status.
6. CS31 power can also be supplied by an adaptor. If necessary, please plug the DC plug of the adaptor into the Power Jack of the CS31, then plug the other end of the adaptor into a standard AC power outlet.

Connection Diagram

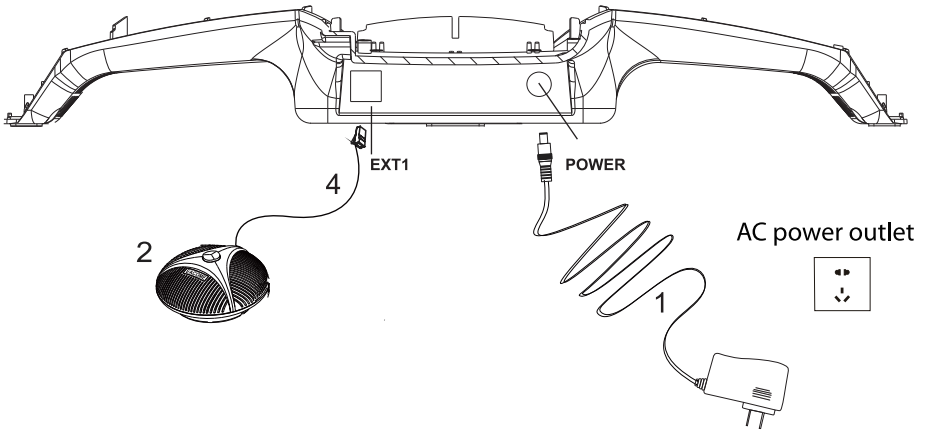

- 1. Power Adaptor
- 2. Extension Microphone 1 (optional)

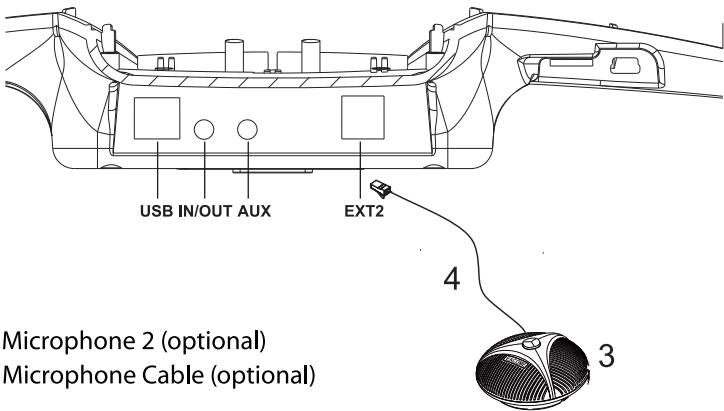

- 3. Extension Microphone 2 (optional)
- 4. Extension Microphone Cable (optional)

Interface Introductions:

- POWER: Power jack on the port bay of the CS31.
- EXT1: EXT1 jack of extension microphone
- EXT2: EXT2 jack of extension microphone
- USB: Connect to PC, or video system.
- AUX: Audio jack connect to external audio device
- IN/OUT: Connect to LINE IN/OUT device, or mobile phone

Self-Detecting:

When the conference phone has access to electricity, the self-detecting program will be activated.

- Red light, blue light and green light flash alternatively three times

3. Getting to Know Your Phone



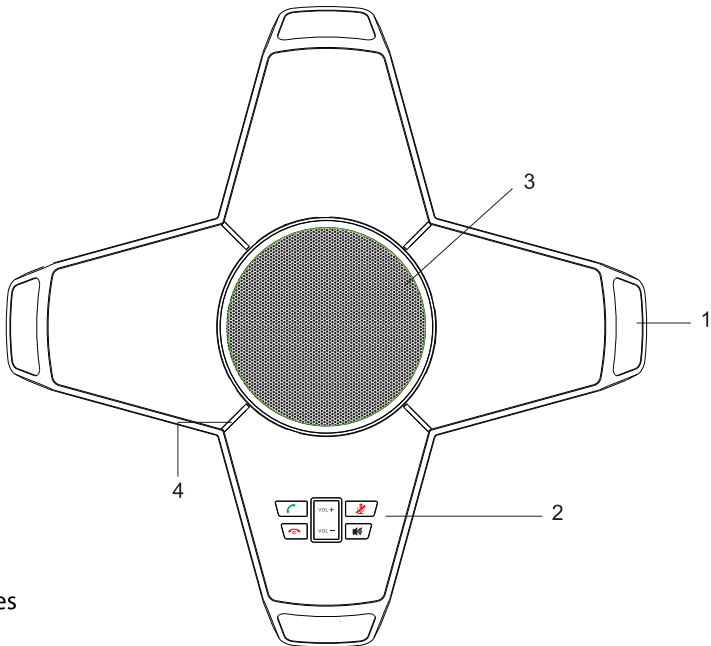





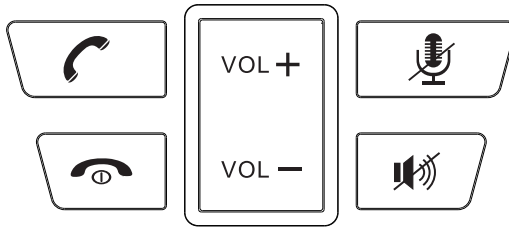



Parts of the Phone



- 1. Microphones
- 2. Keypad
- 3. Speaker
- 4. LED

CS31 Keypad



	Off hook key	Lync off hook
	Hang up key	Lync hang up
	Microphone mute key	Mute microphone
	Speaker mute key	Mute speaker
	Volume up key	Adjust volume up
	Volume down key	Adjust volume down
 	PC Mode	Press “  ” key for two seconds till blue LED indicators will turn on, then press “  ” key and green LED indicators will flash 3 times. “PC MODE” is activated successfully.
 	Mobile Mode	Press “  ” key for two seconds till blue LED indicators will turn on, then press “  ” key and green LED indicators will flash 3 times. “MOBILE MODE” is activated successfully

 If not expected key is pressed during blue LED indicators on, the blue indicators will be off, and mode setting will be terminated

LED Indicators

Blue	USB / Mobile Phone is connected
Red	Microphone mute
Blinking blue	Speaker mute
Blinking green	PC Mode and Mobile Mode switching is undergoing.

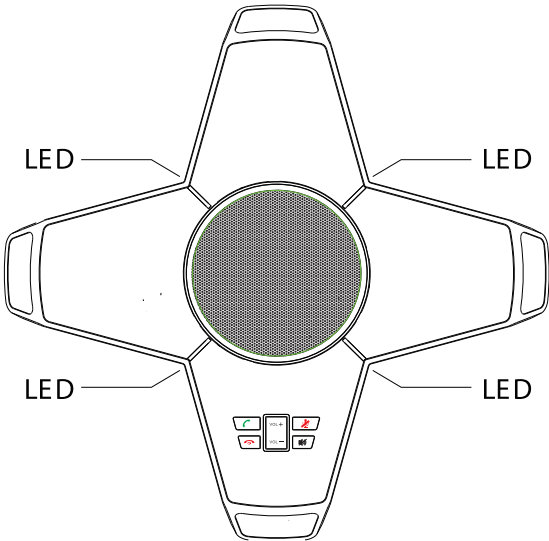

4. How to Use CS31

Placing a VoIP Call in USB Mode

CS31 is able to connect to PC and video conferencing system via USB, providing up to 48 KHz bandwidth for speaker and microphones. Make sure the PC/video devices are ready when placing a call.

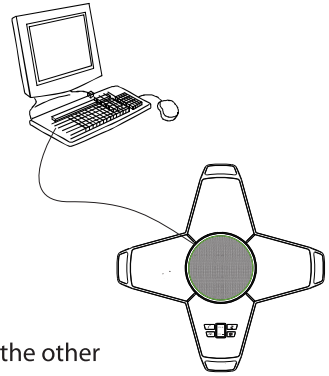

Connection Steps for USB

1. Connect one end of USB cable into PC or video system, the other end into CS31 USB port.
2. It will take a few seconds to install the driver automatically for the first setup.
3. The blue LEDs keep on then CS31 gets into USB mode.
4. Open the softphone platform you select, such as video conference system, video conference software, UC, and other instant communication softwares.

Useful settings for PC and Video Teleconferencing System.

Increase or decrease the volume of speaker and microphone to get the best voice quality for other video teleconferencing system.

Do not activate the automatic gain control (AGC) effect of speaker and microphone.

Do not activate the sound processing effect (such as automatic gain control (AGC), echo cancellation (AEC) and noise suppression (NS)) of software on the PC or video system.

Use HD voice codec if possible.

Placing a Softphone Call via LINE IN/OUT

Method 1

1. Connect the microphone "🎤" and speaker "🎧" port of audio transfer plug to PC or video conferencing system with 3.5mm cable.
2. Insert audio transfer plug into the "IN/OUT" port of CS31.
3. Please set the LINE IN/OUT mode to "PC Mode" (See page 6).

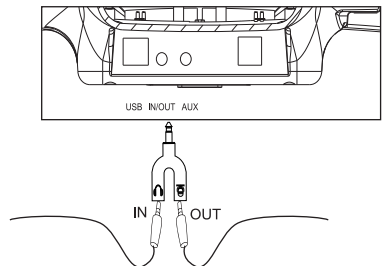

Method 2

1. Connect the "IN/OUT" port of CS31 to the Microphone port of PC or video conferencing system with 3.5mm cable.
2. Please set the LINE IN/OUT mode to "PC Mode" (See page 6).

- ✘ If connect to headset port of laptop or desktop computer、microphone port of video conferencing system,then LINE IN/OUT need switch to “Mobile Mode” (See page6).

Placing a call via Mobile Phone

- ✘ This feature allows you to take advantage of the CS31’s speaker and microphones. For example,if you were in call on your mobile phone,you could connect your mobile phone to continue your conversation and microphones to continue your conversation and include everyone in the room in the conversation.

For these instructions,it is assumed that the mobile phone is turned on ,the mobile phone is on conversation,and the CS31 is connected to the mobile phone via the 3.5mm 4 strand cable.

Connection Steps for Mobile Phone

1. Connect the “IN/OUT” port of CS31 to the earphone port of mobile phone with 3.5mm cable.
2. Please set the LINE IN/OUT mode to “Mobile Mode”(See page6).

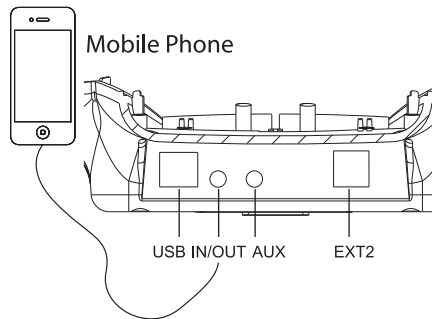

Connection Steps for External Amplifier

- 1.Insert the USB plug into the USB port of CS31.
- 2.Connect the AUX port to the input port of amplifier.
- 3.Connect complete,switch on external amplifier.

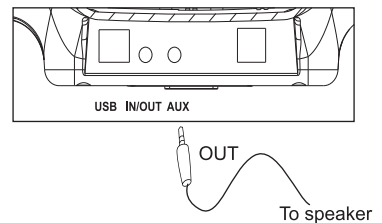

- ✘ It’s recommended to mute the inner speaker but keep the inner microphones on. (Press ‘Speaker mute key’ to mute the speaker)

- ✘ This feature is working only at USB connection

5. Multi-party Conference Call

Multi-party Conference Call & Line Mode Selection

CS31 allows you to hold conference calls via analog LINE IN/OUT(or mobile phone) , USB VOIP simultaneously. All above network will be mixed automatically.You can add another line or switch between connected lines during a call freely.

CS31 supports plug and play for the above kinds of lines conveniently. It is no need to undertake any settings , anytime and anyway.

6. Installing Extension Microphone

For an important meetings or a large meeting,please use extension microphones.

1. Plug the optional extension microphone into the EXT1 and EXT2 jacks of the Conference phone CS31.
2. Plug the DC plug of the adaptor into the POWER jack of the CS31 then plug the other end of the adaptor into a standard AC power outlet .
3. The microphone will pick up well if you are facing it. The inner microphone position is shown as in the figure below .
4. There are MUTE button and status LED on the extension microphone.

🔌 Green LED indicate that microphone is on work.

🔌 Red LED indicate that microphone is muted

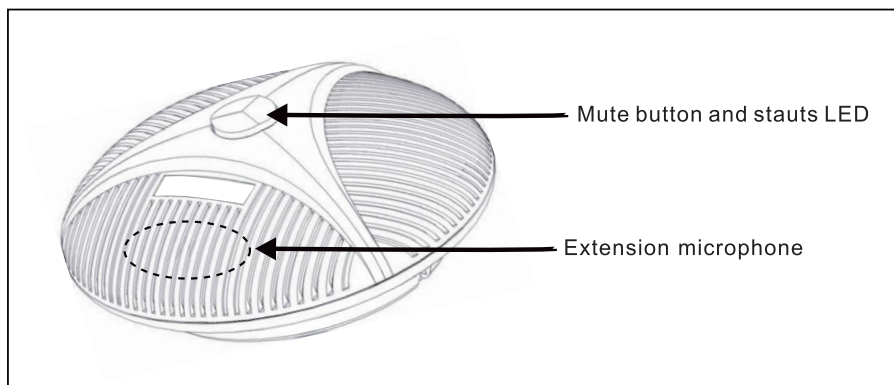

NOTE:

You should plug and pull the cable to extension microphone's 4P4C jacks while power supply is disconnected to ensure microphone work well.

7. Important Safety Instruction

When using your telephone equipment, basic safety precautions should always be followed to reduce the risk of fire, electric shock and injury to persons, including the following:

- This unit is NOT waterproof! DO NOT expose this unit to moisture.
- DO NOT expose this unit to rain.
- Do not use this product near water, for example, near a bath tub, wash bowl, kitchen sink or laundry tub, in a wet basement or near a swimming pool.
- Avoid using a telephone (other than a cordless type) during an electrical storm. There may be a remote risk of electric shock from lightning.
- Do not use the telephone to report a gas leak in the vicinity of the leak.
- Use only the power cord indicated in this manual.

SAVE THESE INSTRUCTIONS!

Important Notice:

Under power failure conditions this appliance may not operate. Please ensure that a separate telephone, not dependent on local power, is available for emergency use.